

Abrazaderas para tubo TrAle

Abrazaderas serie ligera

Abrazadera simple completa, serie ligera

Página: 1/1

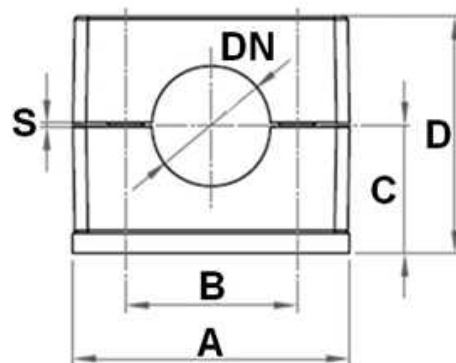

DIN 3015/1

Artículo	DN	GRUPO	CANTIDAD / BOLSA	A	B	C	D	S
A40AZ06	6	1	10	37	20	16.5	30	0.4
A40AZ08	8	1	10	37	20	16.5	30	0.4
A40AZ10	10	1	10	37	20	16.5	30	0.4
A40AZ12	12	1	10	37	20	16.5	30	0.4
A40AZ13.2	1/4"	2	10	42	26	19.5	36	0.6
A40AZ14	14	2	10	42	26	19.5	36	0.6
A40AZ15	15	2	10	42	26	19.5	36	0.6
A40AZ16	16	2	10	42	26	19.5	36	0.6
A40AZ16.7	3/8"	2	10	42	26	19.5	36	0.6
A40AZ18	18	2	10	42	26	19.5	36	0.6
A40AZ19	19	3	10	50	33	21	39	0.6
A40AZ20	20	3	10	50	33	21	39	0.6
A40AZ21.3	1/2"	3	10	50	33	21	39	0.6
A40AZ22	22	3	10	50	33	21	39	0.6
A40AZ25	25	3	10	50	33	21	39	0.6
A40AZ26.7	3/4"	4	10	59	40	24	45	0.6
A40AZ28	28	4	10	59	40	24	45	0.6
A40AZ30	30	4	10	59	40	24	45	0.6
A40AZ32	32	5	10	71	52	32	61	0.8
A40AZ33.3	1"	5	10	71	52	32	61	0.8
A40AZ35	35	5	10	71	52	32	61	0.8
A40AZ38	38	5	10	71	52	32	61	0.8
A40AZ40	40	5	10	71	52	32	61	0.8
A40AZ42	42	5	10	71	52	32	61	0.8
A40AZ48.3	1"1/2	6	10	86	66	36	69	0.8
A40AZ50.8	50.8	6	10	86	66	36	69	0.8

Abrazaderas para tubo TrAle

Abrazaderas serie ligera

Abrazadera completa, serie ligera reforzada

Página: 1/1



DIN 3015/1

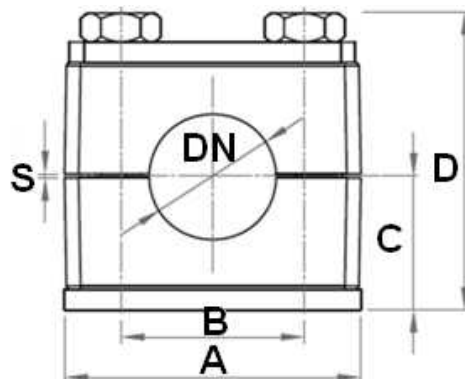

Artículo	DN	GRUPO	CANTIDAD / BOLSA	A	B	C	D	S
A41AZ06	6	1	10	36	20	16.5	37	0.4
A41AZ08	8	1	10	36	20	16.5	37	0.4
A41AZ10	10	1	10	36	20	16.5	37	0.4
A41AZ12	12	1	10	36	20	16.5	37	0.4
A41AZ13.2	1/4"	2	10	42	26	19.5	43	0.6
A41AZ14	14	2	10	42	26	19.5	43	0.6
A41AZ15	15	2	10	42	26	19.5	43	0.6
A41AZ16	16	2	10	42	26	19.5	43	0.6
A41AZ16.7	3/8"	2	10	42	26	19.5	43	0.6
A41AZ18	18	2	10	42	26	19.5	43	0.6
A41AZ20	20	3	10	50	33	21	46	0.6
A41AZ21.3	1/2"	3	10	50	33	21	46	0.6
A41AZ22	22	3	10	50	33	21	46	0.6
A41AZ25	25	3	10	50	33	21	46	0.6
A41AZ26.7	3/4"	4	10	60	40	24	52	0.6
A41AZ28	28	4	10	60	40	24	52	0.6
A41AZ30	30	4	10	60	40	24	52	0.6
A41AZ33.7	1"	5	10	71	52	32	68	0.8
A41AZ35	35	5	10	71	52	32	68	0.8
A41AZ38	38	5	10	71	52	32	68	0.8
A41AZ40	40	5	10	71	52	32	68	0.8
A41AZ42	42	5	10	71	52	32	68	0.8
A41AZ44.5	44.5	6	10	88	66	36	76	0.8
A41AZ48.3	1"1/2	6	10	88	66	36	76	0.8
A41AZ50.8	50.8	6	10	88	66	36	76	0.8

Abrazaderas para tubo TrAle

Plásticos serie ligera

Plásticos polipropileno, serie ligera

Página: 1/1



DIN 3015/1

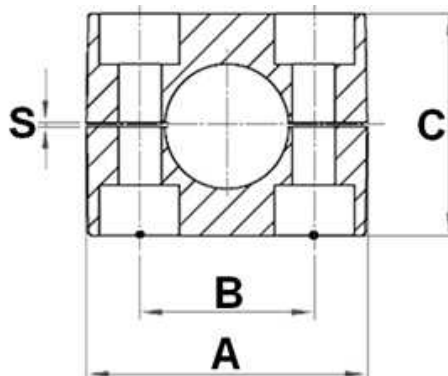

Artículo	DN	GRUPO	A	B	C	S
A106C	6	1	37	20	27	0.4
A108C	8	1	37	20	27	0.4
A110C	10	1	37	20	27	0.4
A112C	12	1	37	20	27	0.4
A213.2C	1/4"	2	42	26	33	0.6
A214C	14	2	42	26	33	0.6
A215C	15	2	42	26	33	0.6
A216.7C	3/8"	2	42	26	33	0.6
A216C	16	2	42	26	33	0.6
A218C	18	2	42	26	33	0.6
A319C	19	3	50	33	36	0.6
A320C	20	3	50	33	36	0.6
A321.3C	1/2"	3	50	33	36	0.6
A322C	22	3	50	33	36	0.6
A323C	23	3	50	33	36	0.6
A325C	25	3	50	33	36	0.6
A426.7C	3/4"	4	59	40	42	0.6
A428C	28	4	59	40	42	0.6
A430C	30	4	59	40	42	0.6
A532C	32	5				
A533.7C	1"	5	71	52	58	0.8
A535C	35	5	71	52	58	0.8
A538C	38	5	71	52	58	0.8
A540C	40	5	71	52	58	0.8
A542C	42	5	71	52	58	0.8
A644.5C	44.5	6	86	66	66	0.8
A648.3C	1"1/2	6	86	66	66	0.8
A650.8C	50.8	6	86	66	66	0.8

Abrazaderas para tubo TrAle

Serie ligera simple y reforzada

Chapas inferiores, serie ligera

Página: 1/1

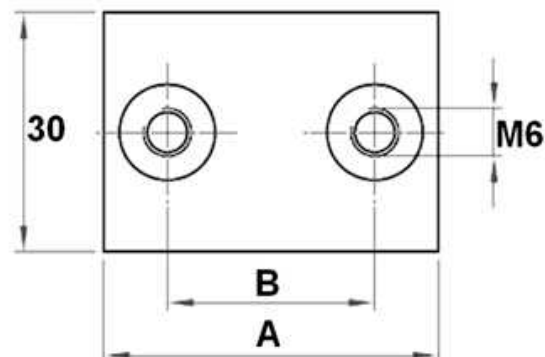
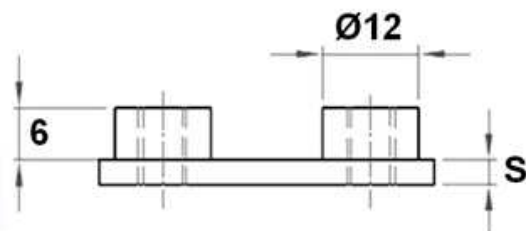

DIN 3015/1

Artículo	GRUPO	A	B	S
APIN1	1	36	20	3
APIN2	2	42	26	3
APIN3	3	50	33	3
APIN4	4	60	40	3
APIN5	5	71	52	3
APIN6	6	88	66	3

Abrazaderas para tubo TrAle

Serie ligera simple y reforzada

Tornillos cabeza Allen, serie ligera

Página: 1/1

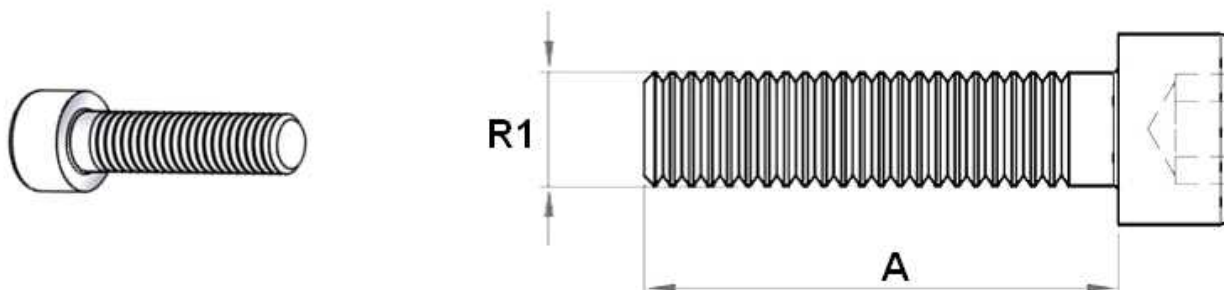

DIN 3015/1

Artículo	R1	GRUPO	A
AVTC1	M6	1	20
AVTC2	M6	2	25
AVTC3	M6	3	30
AVTC4	M6	4	35
AVTC5	M6	5	50
AVTC6	M6	6	60

Abrazaderas para tubo TrAle

Serie ligera simple y reforzada

Chapas superiores, serie ligera reforzada

Página: 1/1

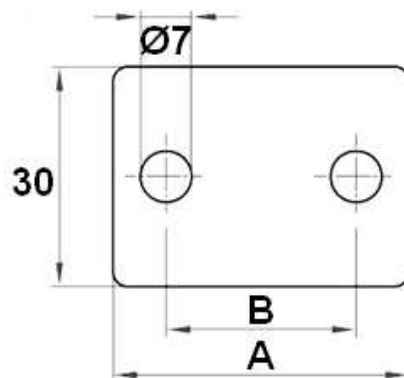
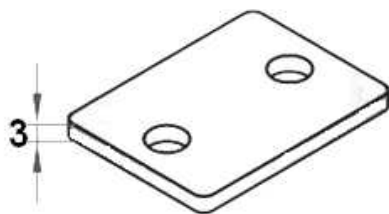

DIN 3015/1

Artículo	GRUPO	A	B
APS1	1	34	20
APS2	2	40	26
APS3	3	48	33
APS4	4	57	40
APS5	5	70	52
APS6	6	86	66

Abrazaderas para tubo TrAle

Serie ligera simple y reforzada

Tornillos cabeza hexagonal, serie ligera reforzada

Página: 1/1

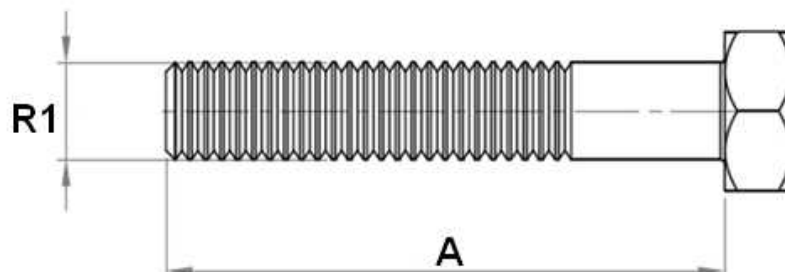
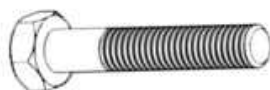

DIN 3015/1

Artículo	R1	GRUPO	A
AVTE1	M6	1	30
AVTE2	M6	2	35
AVTE3	M6	3	40
AVTE4	M6	4	45
AVTE5	M6	5	60
AVTE6	M6	6	70

Abrazaderas para tubo TrAle

Dobles / paralelas

Abrazaderas dobles completas

Página: 1/1



DIN 3015/3

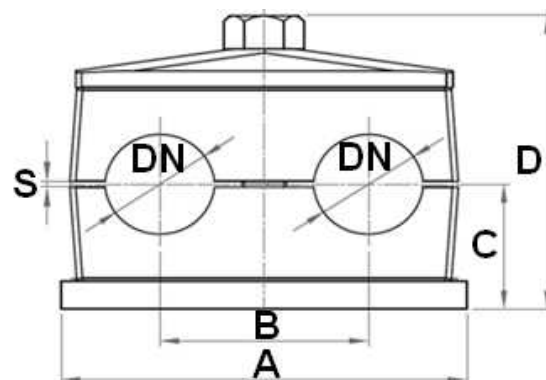
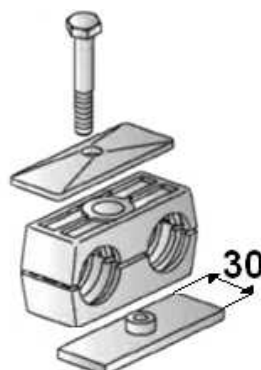

Artículo	DN	GRUPO	CANTIDAD / BOLSA	A	B	C	D	S
AZCFS06	6	1	10	37	20	16.5	41	0.6 min
AZCFS08	8	1	10	37	20	16.5	41	0.6 min
AZCFS10	10	1	10	37	20	16.5	41	0.6 min
AZCFS12	12	1	10	37	20	16.5	41	0.6 min
AZCFS13.2	1/4"	2	10	55	29	18.5	44.5	0.7 min
AZCFS14	14	2	10	55	29	18.5	44.5	0.7 min
AZCFS15	15	2	10	55	29	18.5	44.5	0.7 min
AZCFS16	16	2	10	55	29	18.5	44.5	0.7 min
AZCFS16.7	3/8"	2	10	55	29	18.5	44.5	0.7 min
AZCFS18	18	2	10	55	29	18.5	44.5	0.7 min
AZCFS19	19	3	10	70	36	23.5	54.5	0.7 min
AZCFS20	20	3	10	70	36	23.5	54.5	0.7 min
AZCFS21.3	1/2"	3	10	70	36	23.5	54.5	0.7 min
AZCFS22	22	3	10	70	36	23.5	54.5	0.7 min
AZCFS25	25	3	10	70	36	23.5	54.5	0.7 min
AZCFS26.7	3/4"	4	10	85	45	25.5	58.5	0.7 min
AZCFS28	28	4	10	85	45	25.5	58.5	0.7 min
AZCFS30	30	4	10	85	45	25.5	58.5	0.7 min
AZCFS32	32	5	10	110	56	32	71.5	0.7 min
AZCFS33.3	1"	5	10	110	56	32	71.5	0.7 min
AZCFS35	35	5	10	110	56	32	71.5	0.7 min
AZCFS38	38	5	10	110	56	32	71.5	0.7 min
AZCFS40	40	5	10	110	56	32	71.5	0.7 min
AZCFS42	42	5	10	110	56	32	71.5	0.7 min

Abrazaderas para tubo TrAle

Dobles / paralelas

Chapas inferiores

Página: 1/1

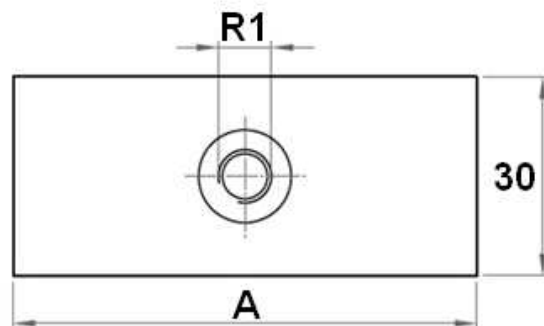
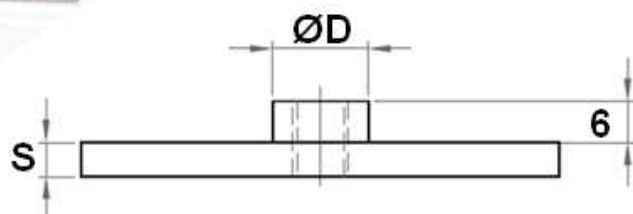

DIN 3015/3

Artículo	R1	GRUPO	ØD	A	S
ADPIN1	M6	1	12	37	3
ADPIN2	M8	2	14	55	5
ADPIN3	M8	3	14	70	5
ADPIN4	M8	4	14	85	5
ADPIN5	M8	5	14	110	5

TrAle®**FLUIDAL**

Abrazaderas para tubo TrAle

Dobles / paralelas

Plásticos polipropileno dobles

Página: 1/1

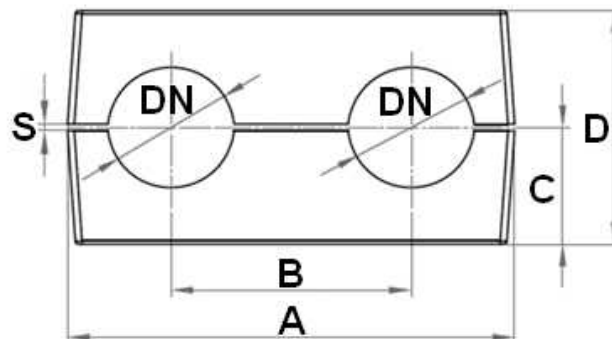

DIN 3015/3

Artículo	DN	GRUPO	A	B	C	D	S
AD106C	6	1	36	20	13.5	27	0.6 min
AD108C	8	1	36	20	13.5	27	0.6 min
AD110C	10	1	36	20	13.5	27	0.6 min
AD112C	12	1	36	20	13.5	27	0.6 min
AD213.2C	1/4"	2	53	29	13.5	27	0.7 min
AD214C	14	2	53	29	13.5	27	0.7 min
AD215C	15	2	53	29	13.5	27	0.7 min
AD216.7C	3/8"	2	53	29	13.5	27	0.7 min
AD216C	16	2	53	29	13.5	27	0.7 min
AD218C	18	2	53	29	13.5	27	0.7 min
AD319C	19	3	67	36	18.5	37	0.7 min
AD320C	20	3	67	36	18.5	37	0.7 min
AD321.3C	1/2"	3	67	36	18.5	37	0.7 min
AD322C	22	3	67	36	18.5	37	0.7 min
AD325C	25	3	67	36	18.5	37	0.7 min
AD426.7C	3/4"	4	82	45	20.5	41	0.7 min
AD428C	28	4	82	45	20.5	41	0.7 min
AD430C	30	4	82	45	20.5	41	0.7 min
AD532C	32	5	106	56	27	54	0.7 min
AD533.3C	1"	5	106	56	27	54	0.7 min
AD535C	35	5	106	56	27	54	0.7 min
AD538C	38	5	106	56	27	54	0.7 min
AD540C	40	5	106	56	27	54	0.7 min
AD542C	42	5	106	56	27	54	0.7 min

TrAle®

FLUIDAL

Abrazaderas para tubo TrAle

Dobles / paralelas

Chapas superiores

Página: 1/1

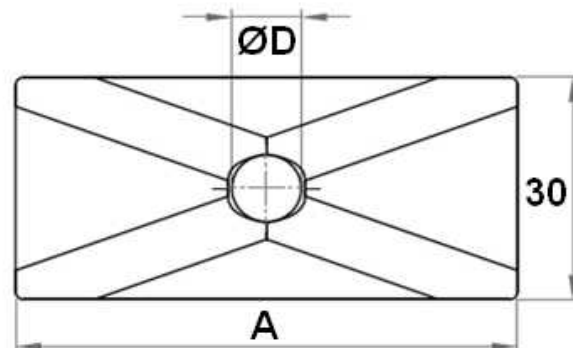
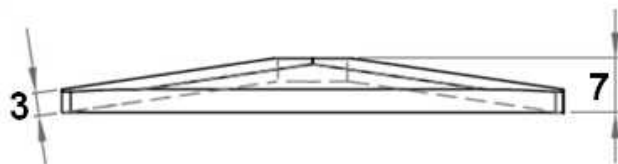

DIN 3015/3

Artículo	GRUPO	ØD	A
ADPS1	1	7	34
ADPS2	2	9	52
ADPS3	3	9	65
ADPS4	4	9	79
ADPS5	5	9	96

Abrazaderas para tubo TrAle

Dobles / paralelas

Tornillos cabeza hexagonal

Página: 1/1

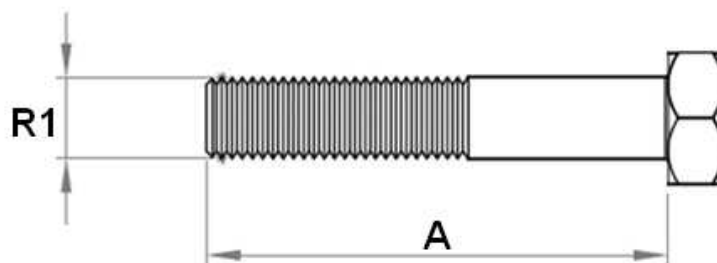
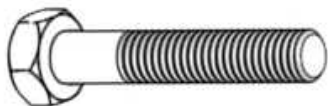

DIN 3015/3

Artículo	R1	GRUPO	A
ADVTE1	M6	1	35
ADVTE2	M8	2	35
ADVTE3	M8	3	45
ADVTE4	M8	4	50
ADVTE5	M8	5	60

Abrazaderas para tubo TrAle

Serie pesada

Plásticos polipropileno, serie pesada

Página: 1/2

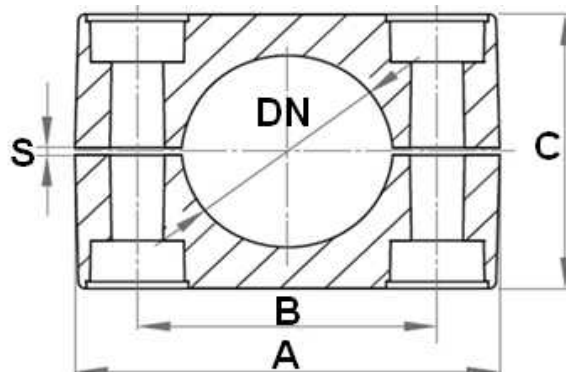
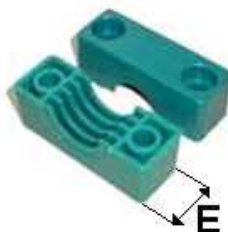

DIN 3015/2

Artículo	DN	GRUPO	A	B	C	E	S
AMPP117.2C	3/8"	1					
AMPP106C	6	1	55	33	32	30	0.6 min
AMPP108C	8	1	55	33	32	30	0.6 min
AMPP110C	10	1	55	33	32	30	0.6 min
AMPP112C	12	1	55	33	32	30	0.6 min
AMPP113.2C	1/4"	1	55	33	32	30	0.6 min
AMPP114C	14	1	55	33	32	30	0.6 min
AMPP115C	15	1	55	33	32	30	0.6 min
AMPP116C	16	1	55	33	32	30	0.6 min
AMPP118C	18	1	55	33	32	30	0.6 min
AMPP220C	20	2	70	45	48	30	0.6 min
AMPP221.3C	1/2"	2	70	45	48	30	0.6 min
AMPP222C	22	2	70	45	48	30	0.6 min
AMPP225C	25	2	70	45	48	30	0.6 min
AMPP226.7C	3/4"	2	70	45	48	30	0.6 min
AMPP228C	28	2	70	45	48	30	0.6 min
AMPP230C	30	2	70	45	48	30	0.6 min
AMPP330C	30	3	85	60	60	30	0.6 min
AMPP332C	32	3	85	60	60	30	0.6 min
AMPP333.3C	1"	3	85	60	60	30	0.6 min
AMPP335C	35	3	85	60	60	30	0.6 min
AMPP338C	38	3	85	60	60	30	0.6 min
AMPP340C	40	3	85	60	60	30	0.6 min
AMPP342C	42	3	85	60	60	30	0.6 min
AMPP438C	38	4	115	90	89	45	2 min
AMPP442C	42	4	115	90	89	45	2 min
AMPP445C	45	4	115	90	89	45	2 min
AMPP448.4C	1"1/2	4	115	90	89	45	2 min
AMPP448C	48	4	115	90	89	45	2 min
AMPP450C	50	4	115	90	89	45	2 min

TrAle®

FLUIDAL

Abrazaderas para tubo TrAle

Serie pesada

Plásticos polipropileno, serie pesada**Página: 2/2**

Artículo	DN	GRUPO	A	B	C	E	S
AMPP455C	55	4	115	90	89	45	2 min
AMPP460.3C	2"	4	115	90	89	45	2 min
AMPP465C	65	4	115	90	89	45	2 min
AMPP470C	70	4	115	90	89	45	2 min

Abrazaderas para tubo TrAle

Serie pesada

Tornillos cabeza hexagonal, serie pesada

Página: 1/1

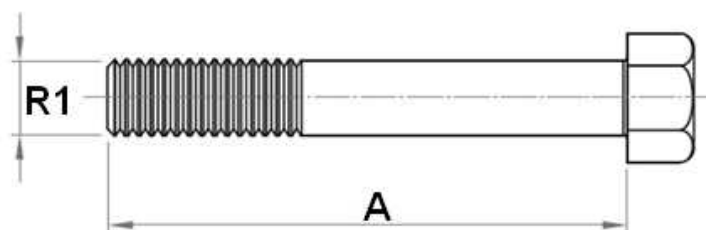
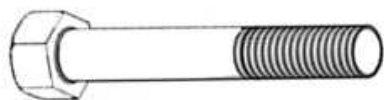

DIN 3015/2

Artículo	R1	GRUPO	A
AVTEP1	M10	1	45
AVTEP2	M10	2	60
AVTEP3	M10	3	70
AVTEP4	M12	4	100

Abrazaderas para tubo TrAle

Serie pesada

Tornillo para serie pesada apilable



1/1

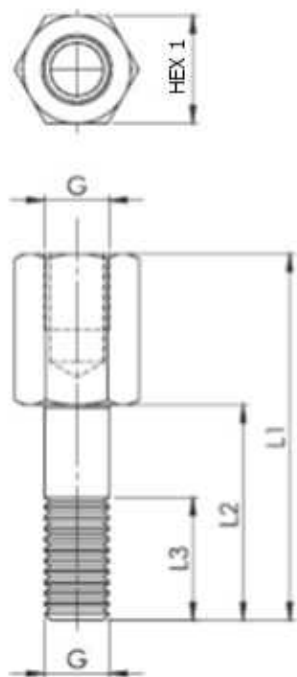

Artículo	R1	GRUPO	L1	L2	L3	HEX 1
APVTA1	M10	1	49	24	25	15
APVTA2	M10	2	65	40	15	15
APVTA3	M10	3	74	50	15	15
APVTA4	M12	4	108	81	18	17

Abrazaderas para tubo TrAle

Serie pesada

Chapas inferiores, serie pesada

Página: 1/1

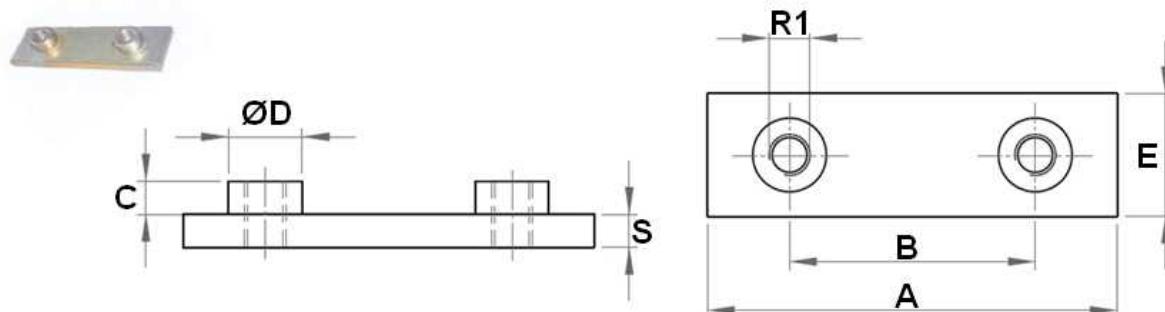

DIN 3015/2

Artículo	R1	GRUPO	ØD	A	B	C	E	S
APINP1	M10	1	18	74	33	8	30	8
APINP2	M10	2	18	86	45	8	30	8
APINP3	M10	3	18	100	60	8	30	8
APINP4	M12	4	20	140	90	8	45	10

Abrazaderas para tubo TrAle

Serie pesada

Chapas superiores, serie pesada

Página: 1/1

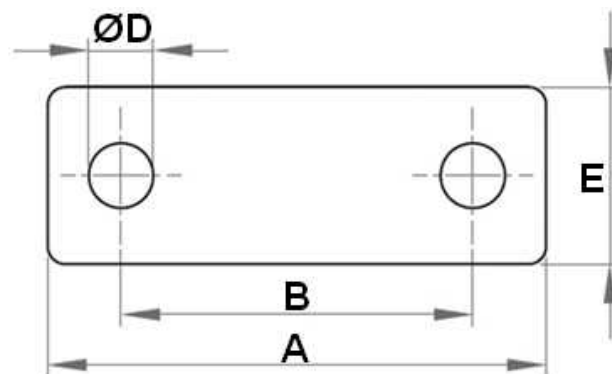
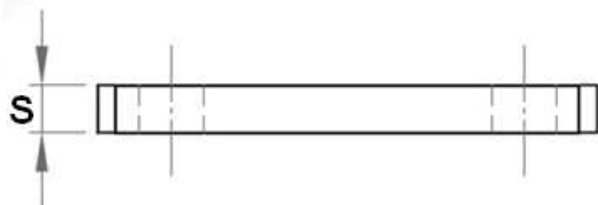

DIN 3015/2

Artículo	GRUPO	ØD	A	B	E	S
APSP1	1	11	55	33	30	8
APSP2	2	11	70	45	30	8
APSP3	3	11	85	60	30	8
APSP4	4	14	115	90	45	10

TrAle®**FLUIDAL**

Abrazaderas para tubo TrAle

Serie pesada

Abrazadera completa, serie pesada

Página: 1/2

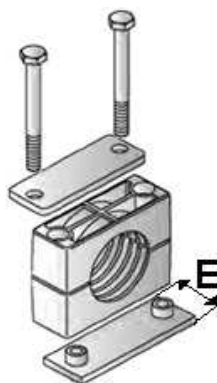

DIN 3015/2

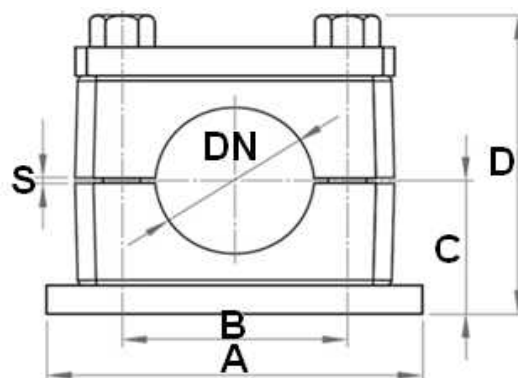

Artículo	DN	GRUPO	A	B	C	D	E	S
AZCPS06	6	1	74	33	24	55	30	0.6
AZCPS08	8	1	74	33	24	55	30	0.6
AZCPS10	10	1	74	33	24	55	30	0.6
AZCPS12	12	1	74	33	24	55	30	0.6
AZCPS13.2	1/4"	1	74	33	24	55	30	0.6
AZCPS14	14	1	74	33	24	55	30	0.6
AZCPS15	15	1	74	33	24	55	30	0.6
AZCPS16	16	1	74	33	24	55	30	0.6
AZCPS18	18	1	74	33	24	55	30	0.6
AZCPS20	20	2	86	45	32	71	30	0.6
AZCPS21.3	1/2"	2	86	45	32	71	30	0.6
AZCPS22	22	2	86	45	32	71	30	0.6
AZCPS25	25	2	86	45	32	71	30	0.6
AZCPS26.7	3/4"	2	86	45	32	71	30	0.6
AZCPS28	28	2	86	45	32	71	30	0.6
AZCPS30	30	2	86	45	32	71	30	0.6
AZCPS32	32	3	100	60	38	83	30	0.6
AZCPS33.3	1"	3	100	60	38	83	30	0.6
AZCPS35	35	3	100	60	38	83	30	0.6
AZCPS38	38	3	100	60	38	83	30	0.6
AZCPS40	40	3	100	60	38	83	30	0.6
AZCPS42	42	3	100	60	38	83	30	0.6
AZCPS42.4	1"1/4	4	140	90	54.5	117	45	2
AZCPS45	45	4	140	90	54.5	117	45	2
AZCPS48	48	4	140	90	54.5	117	45	2
AZCPS48.4	1"1/2	4	140	90	54.5	117	45	2
AZCPS50	50	4	140	90	54.5	117	45	2
AZCPS55	55	4	140	90	54.5	117	45	2
AZCPS60	60	4	140	90	54.5	117	45	2
AZCPS60.3	2"	4	140	90	54.5	117	45	2

TrAle®

FLUIDAL

Abrazaderas para tubo TrAle

Serie pesada

Abrazadera completa, serie pesada**Página: 2/2**

Artículo	DN	GRUPO	A	B	C	D	E	S
AZCPS65	65	4	140	90	54.5	117	45	2
AZCPS70	70	4	140	90	54.5	117	45	2

Abrazaderas para tubo TrAle

Accesorios abrazaderas

Chapa agrupar abrazaderas simples

Página: 1/1

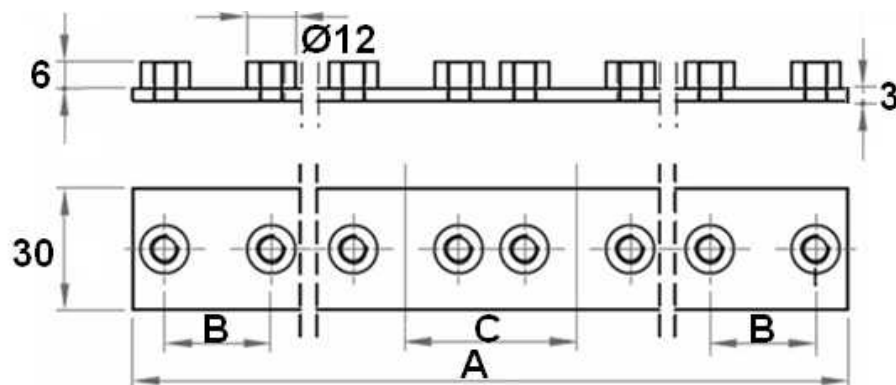
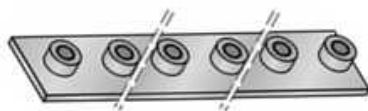

DIN 3015/1

Artículo	GRUPO	Nº Abrazaderas	A	B	C
APAG1	1	10	373	20	37
APAG2	2	10	442	26	44
APAG3	3	10	521	33	52

Abrazaderas para tubo TrAle

Accesorios abrazaderas

Accesorios carril

Página: 1/1

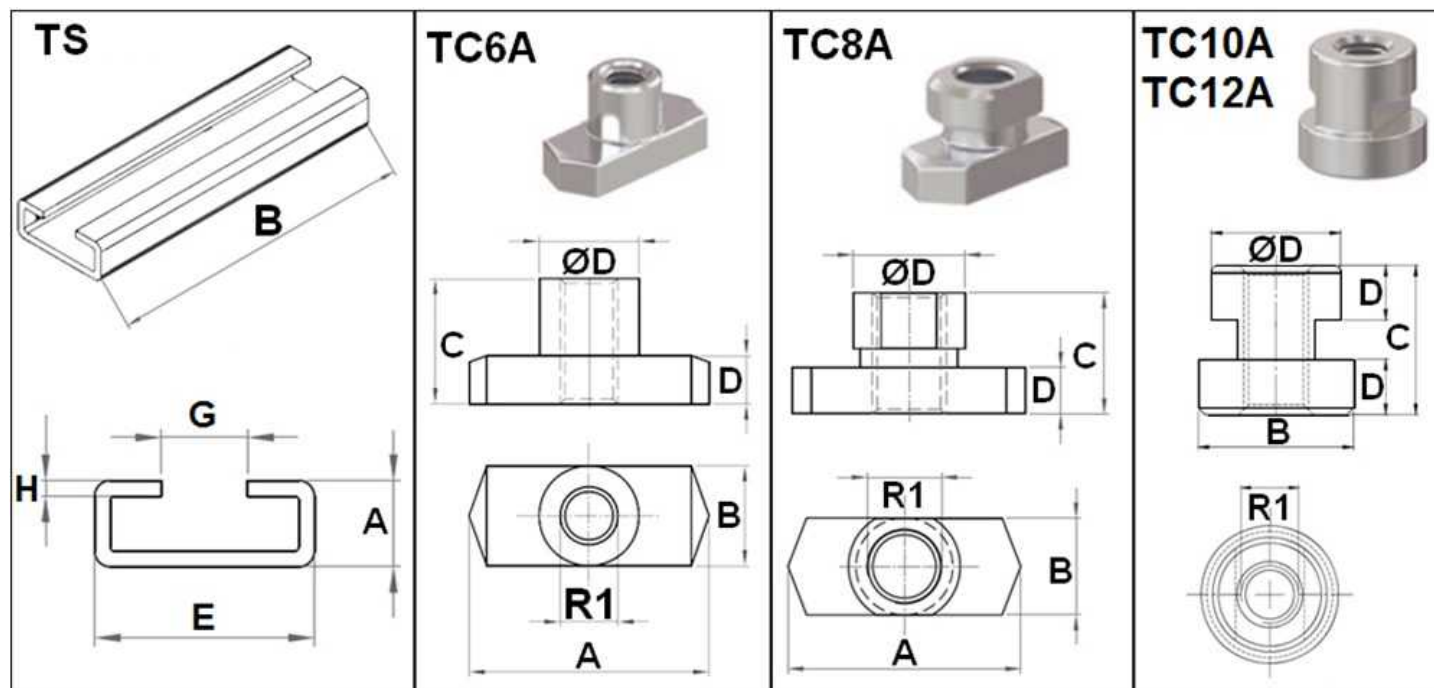

Artículo	R1	Tamaño	Detalles	Tipo	ØD	A	B	C	D	E	G	H
TC6A	M6	--	Tuerca carril	Serie Simple G1...G8/Serie Doble G1	10	25,4	10,4	13	5			
TC8A	M8	--	Tuerca carril	Para dobles 2, 3, 4, 5	14	25,4	10,4	13	5			
TC10A	M10	--	Tuerca carril	Serie pesada 1, 2, 3	17,8		24	21	7,5			
TC12A	M12	--	Tuerca carril	Serie pesada gr.4	19,8		24	23	8,5			
TS11A	--	11x28	Carril guía	Simples/dobles		11	1			28	11	2
TS14A	--	14x28	Carril guía	Simples/dobles		14	1			28	11	2
TSP22	--	22x40	Carril guía	Serie Pesada		22	1			40	14	5

Abrazaderas para tubo TrAle

Accesorios abrazaderas

Chapa agrupar abrazaderas dobles

Página: 1/1

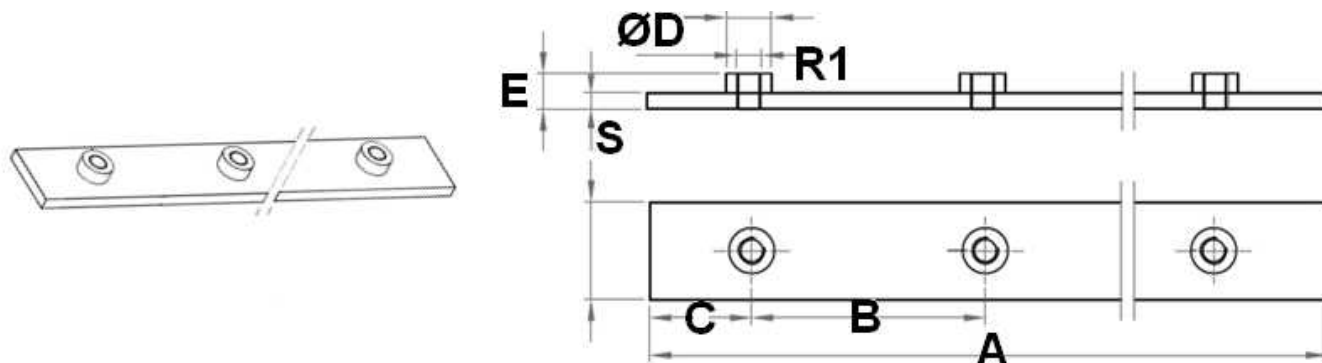

DIN 3015/3

Artículo	R1	GRUPO	Nº Abrazaderas	ØD	A	B	C	E	S
ADPAG1	M6	1	5	12	196	40	18	9	3
A2DPIN2	M8	2	2	14	114	58	28	11	5
A3DPIN2	M8	2	3	14	172	58	28	11	5
ADPAG2	M8	2	5	14	288	58	28	11	5
A3DPIN3	M8	3	3	14	214	72	35	11	5
ADPAG3	M8	3	5	14	358	72	35	11	5

Abrazaderas para tubo TrAle

Accesorios abrazaderas

Chapa atornillar Abr. Simples

Página: 1/1

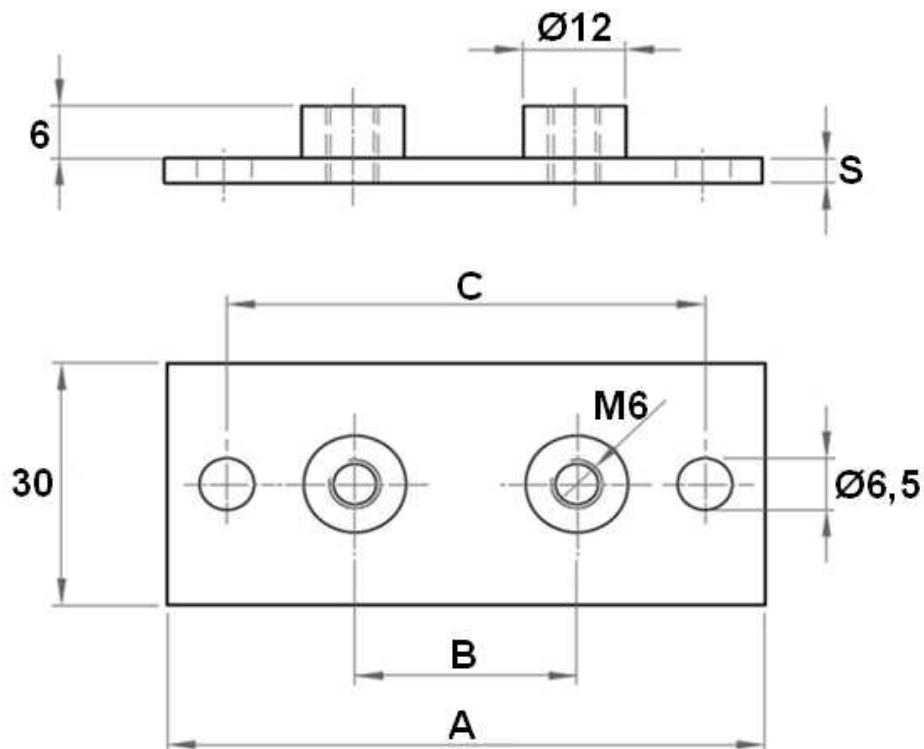
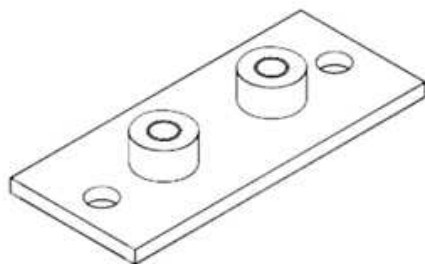

DIN 3015/1

Artículo	GRUPO	A	B	C	S
APT1	1	64	20	50	3
APT2	2	70	26	56	3
APT3	3	78	33	64	3
APT4	4	87	40	73	3
APT5	5	100	52	86	3

Abrazaderas para tubo TrAle

Accesorios para apilar

Tornillo apilar ligera

Página: 1/1

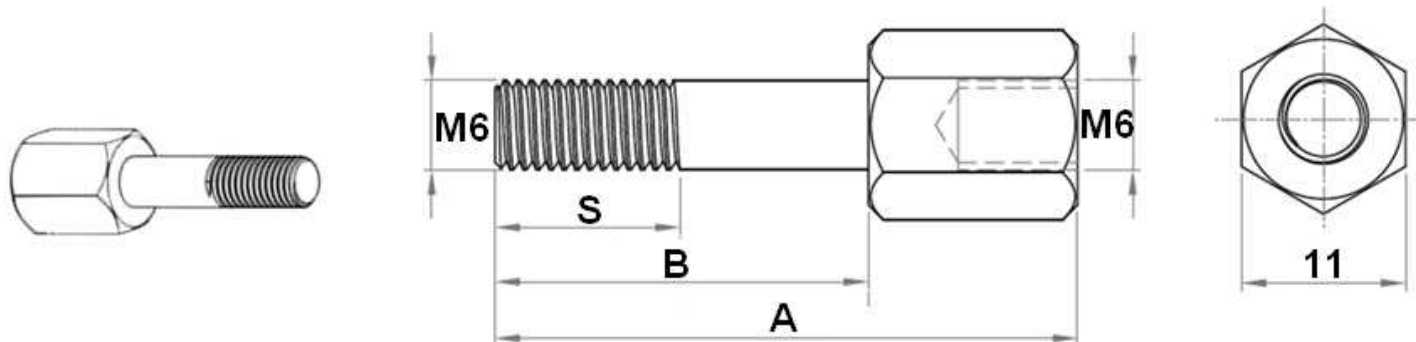

DIN 3015/1

Artículo	R1	GRUPO	A	B	S
AVTA1	M6	1	34	20	12 min
AVTA2	M6	2	39	25	12 min
AVTA3	M6	3	44	30	12 min
AVTA4	M6	4	48	35	12 min
AVTA5	M6	5	64	50	12 min

TrAle®

FLUIDAL

Abrazaderas para tubo TrAle

Accesorios para apilar

Chapa apilar doble

Página: 1/1

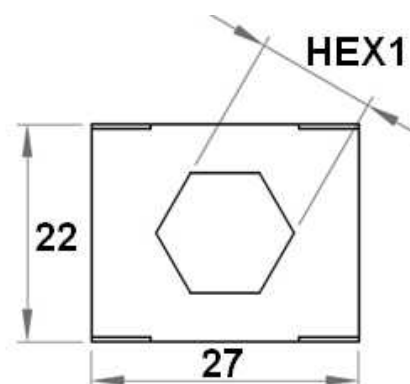
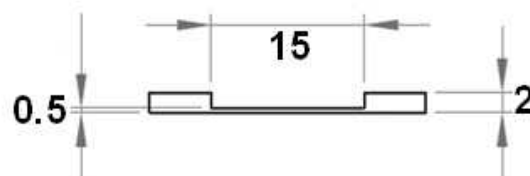
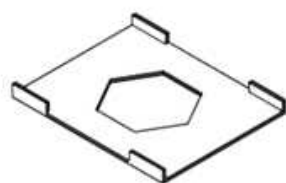

DIN 3015/3

Artículo	GRUPO	HEX 1
ADPA1	1	11.1
ADPA2	2/3/4/5	12.1

Abrazaderas para tubo TrAle

Accesorios para apilar

Tornillo apilar doble

Página: 1/1

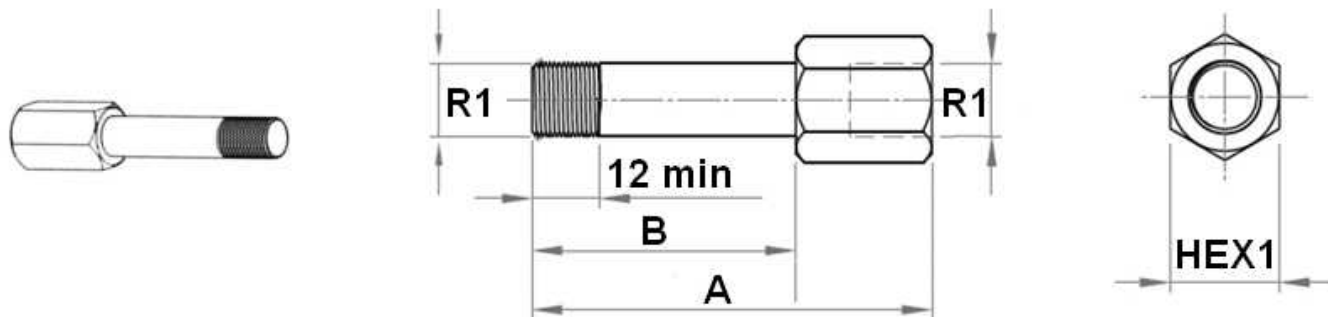

DIN 3015/3

Artículo	R1	GRUPO	HEX 1	A	B
ADVTA2	M8	2	12	34	20
ADVTA3	M8	3	12	44	29
ADVTA4	M8	4	12	49	34

Abrazaderas para tubo TrAle

Accesorios para apilar

Chapa apilar ligera

Página: 1/1

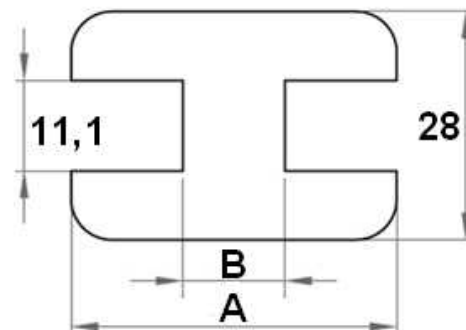

DIN 3015/1

Artículo	GRUPO	A	B
APA1	1	34	7
APA2	2	40	13
APA3	3	48	20
APA4	4	57	27
APA5	5	69	39

Abrazaderas para tubo TrAle

Abrazaderas anti-vibración

Plásticos para abrazaderas anti-vibración



1/1



Plásticos polipropileno negro

Inserto: Elastómero TPE 60 Shore A

Artículo	DN	Serie	GRUPO
AML401270	12.7	L	4
AML401400	14	L	4
AML401900	19	L	4
AML602200	22	L	6
AML602800	28	L	6
AML603000	30	L	6
AMS403500	35	S	4
AMS403800	38	S	4

para dimensiones de plásticos ver fichas abrazaderas simples o pesadas